

INDICE

BC-055

5x18 mm

pag. 2 a 7

BC-255

5x25 mm

pag. 8 a 10

BC-080

8x18 mm

pag. 11 a 12

BC-I80

8x18 mm

pag. 13 a 17

BC-258

8x25 mm

pag. 18 a 21

BC-068

6x8 mm

pag. 22 a 25

BC-525 ASTUR.

5x25 mm

pag. 26 a 29

BC-725 ASTUR.

7,5x25 mm

pag. 30 a 32

BX-725

7x25 mm

pag. 33 a 38

BX-255

5x25 mm

pag. 39 y 40



BARROTILO INTERIOR

BC-055

BARROTILOS

LACADO

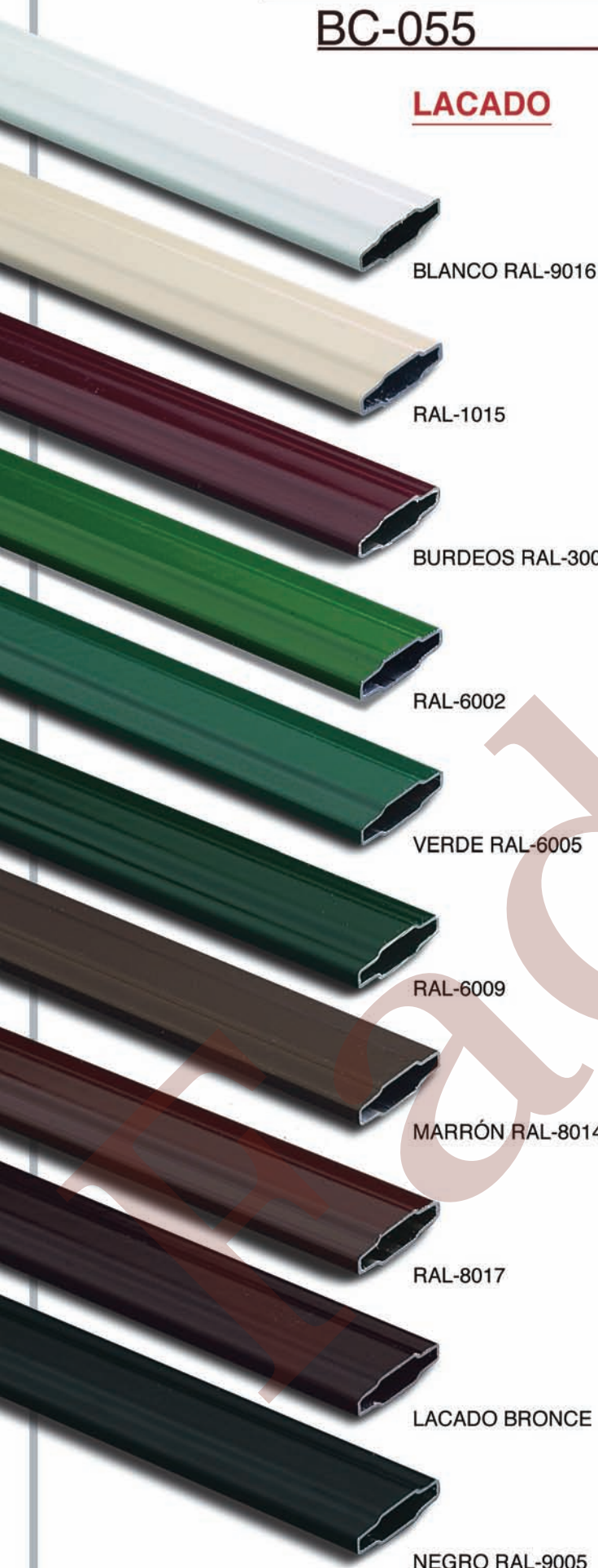
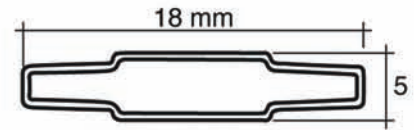

BLANCO RAL-9016

RAL-1015

BURDEOS RAL-3005

RAL-6002

VERDE RAL-6005

RAL-6009

MARRÓN RAL-8014

RAL-8017

LACADO BRONCE

NEGRO RAL-9005

referencias	ml/caja*
LACADO	
BLANCO	648
BLANCO C.P.	600
RAL-1015 C.P.	600
RAL-3005 C.P.	600
RAL-6002 C.P.	600
RAL-6005 C.P.	600
RAL-6009 C.P.	600
RAL-8014 C.P.	600
RAL-8017 C.P.	600
LAC. BRONCE C.P.	600
RAL-9005 C.P.	600

*metros lineales por caja

■ **NOTA:** Todos con cruceta exterior.



BARROTILO INTERIOR

BC-055

BARROTILOS

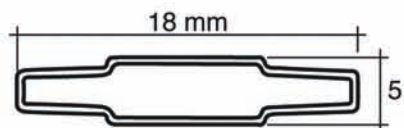

ANODIZADO

ANODIZADO BRONCE

ANODIZADO INOX

ANODIZADO ORO

ANODIZADO PLATA

referencias	ml/caja*
ANODIZADO	
ANOD. BRONCE	300
ANOD. INOX	300
ANOD. ORO	300
ANOD. PLATA	300

*metros lineales por caja

METALIZADO

BRONCE METALIZADO

ORO METALIZADO

PLATA METALIZADO

referencias	ml/caja*
METALIZADO	
BRONCE METAL.	324
ORO METAL.	324
PLATA METAL.	324

*metros lineales por caja

■ **NOTA:** Metalizados con cruceta exterior.

BARROTILO INTERIOR

BC-055

BARROTILOS

LACADO EN MADERA

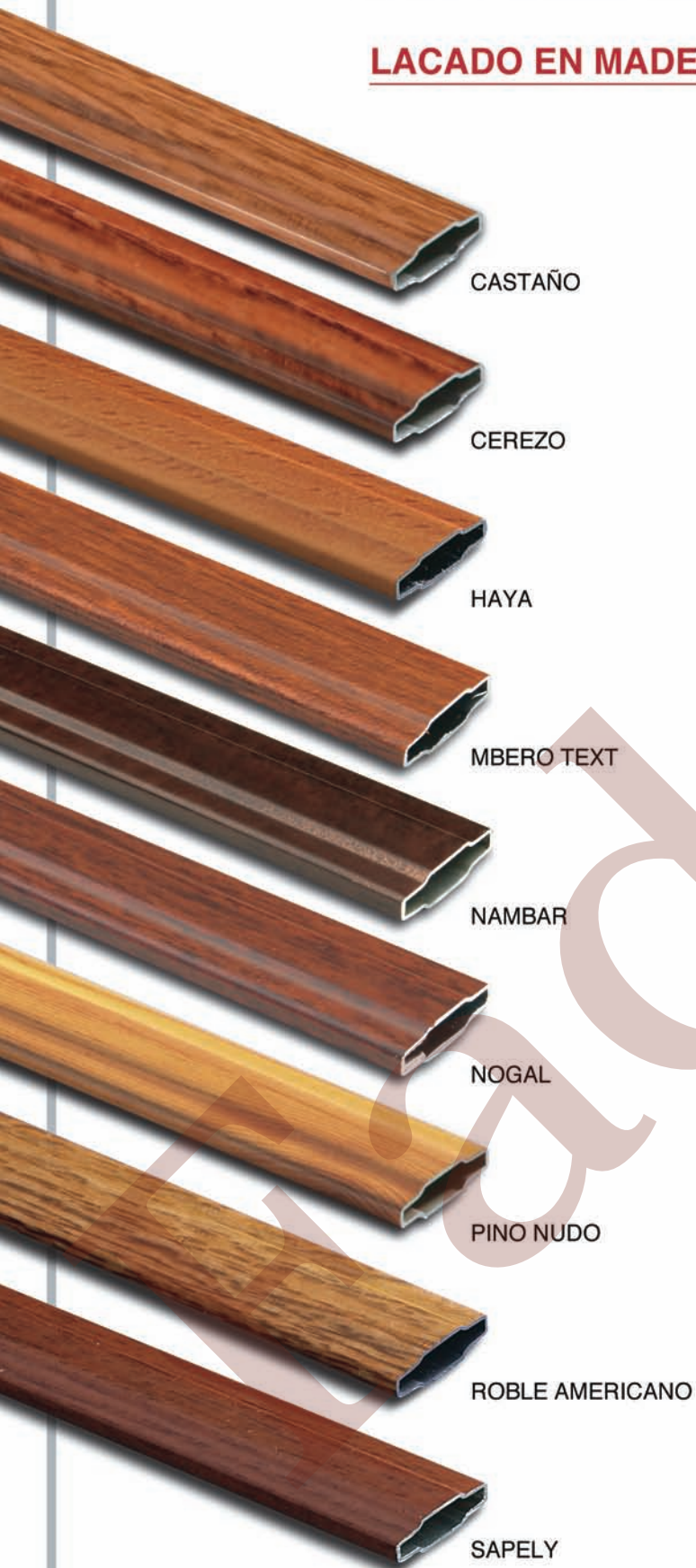
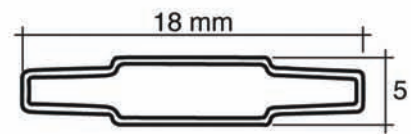

referencias	ml/caja*
LACADO MADERA	
CASTAÑO	324
CEREZO	324
HAYA	324
MBERO TEXT	324
NAMBAR	324
NOGAL	324
PINO NUDO	300
ROBLE AMER.	324
SAPELY	324

*metros lineales por caja

NOTA: Todos con cruceta exterior excepto: mbero text, nambar, nogal y pino nudo.



GOBIERNO DEL PRINCIPADO DE ASTURIAS
IDEPA

Instituto de Investigación Económica del Principado de Asturias



FEDEP

BARROTILLO INTERIOR

BC-055

BARROTILLOS

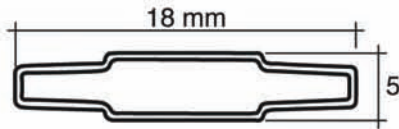

FOLEADO

RENOLIT 2052089

RENOLIT 2052090

RENOLIT 2097013

RENOLIT 2178001

RENOLIT 2178007

RENOLIT 3069041

RENOLIT 3118076

RENOLIT 3149008

RENOLIT 3162002

referencias	ml/caja*
FOLEADO	
REN. 2052089	285
REN. 2052090	285
REN. 2097013	285
REN. 2178001	285
REN. 2178007	285
REN. 3069041	285
REN. 3118076	285
REN. 3149008	285
REN. 3162002	285

*metros lineales por caja

■ **NOTA:** Todos con cruceta interior.



BARROTILO INTERIOR

BC-055

ACCESORIOS



Ref.: **X-055**

Cruceta exterior

500 uds/caja



Ref.: **XI-055**

Cruceta interior

500 uds/caja



Ref.: **XY-055**

Cruceta tres salidas 90°

500 uds/caja



Ref.: **XY60°-055**

Cruceta tres salidas 60°

500 uds/caja



Ref.: **XY120°-055**

Cruceta tres salidas 120°

500 uds/caja



Ref.: **XZ-055**

Cruceta exterior de zamac

500 uds/caja



Ref.: **PS-055**

Pasador para TCI

1000 uds/caja



Ref.: **TCI-055**

Tope interior

1000 uds/bolsa



Ref.: **TC-055**

Tope cabeza bola

1000 uds/bolsa



Ref.: **TCF-055**

Tope cabeza flecha

1000 uds/bolsa



Ref.: **TCS-055**

Tope para grapar

1000 uds/bolsa



GOBIERNO DEL PRINCIPADO DE ASTURIAS



Instituto de Investigación Económica del Principado de Asturias



6

BARROTILO INTERIOR

BC-055

EJEMPLOS DE MONTAJE

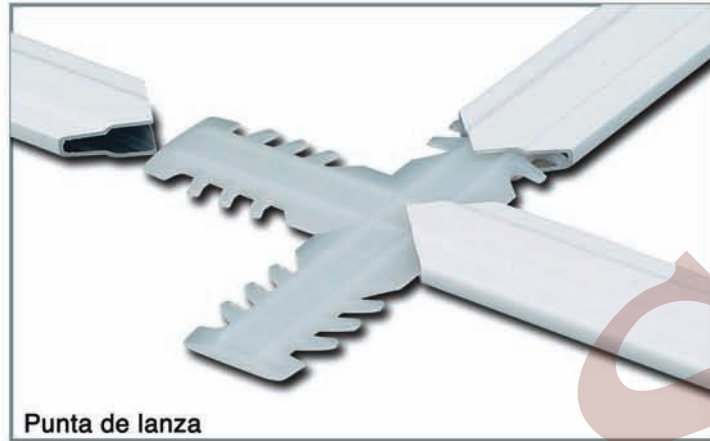

EJEMPLO DE COMBINACIONES

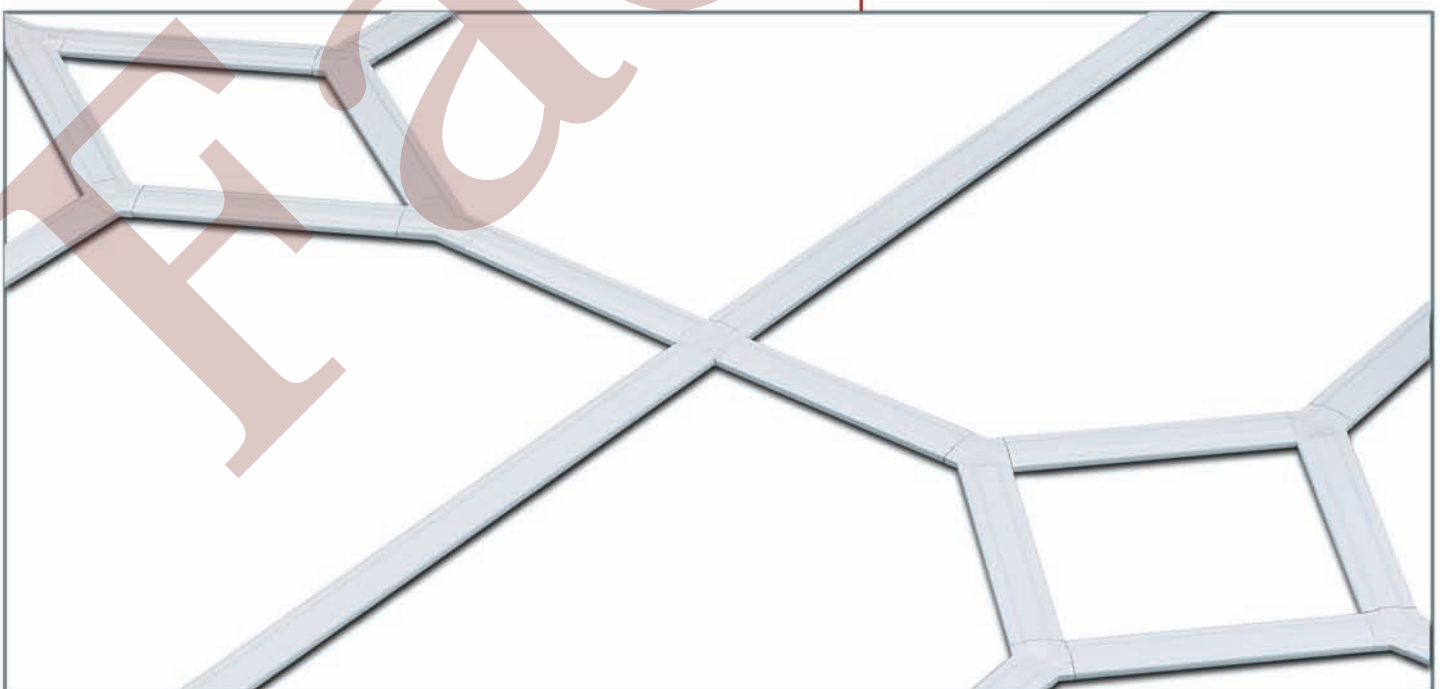

BARROTILO INTERIOR

BC-255

BARROTILLOS

LACADO

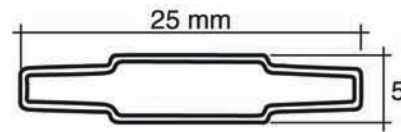

BLANCO RAL-9016

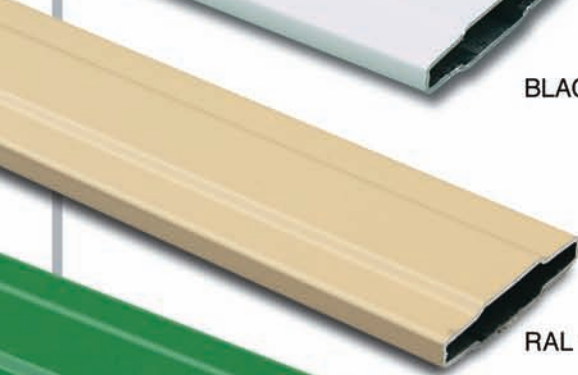

RAL 1015



RAL 6002

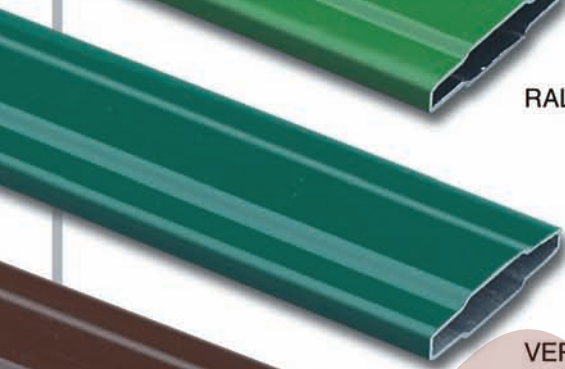

VERDE RAL 6005

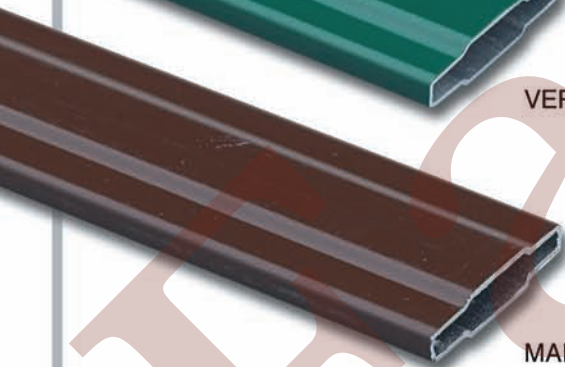

MARRON RAL 8014

referencias	ml/caja*
LACADO	
BLANCO	450
BLANCO C.P.	360
RAL-1015 C.P.	360
RAL-6002 C.P.	360
RAL-3005 C.P.	360
RAL-8014 C.P.	360

*metros lineales por caja

■ **NOTA:** Todos con cruceta exterior.



GOBIERNO DEL PRINCIPADO DE ASTURIAS
IDEPA

Instituto de Desarrollo Económico del Principado de Asturias



FEDES

BARROTILO INTERIOR

BC-255

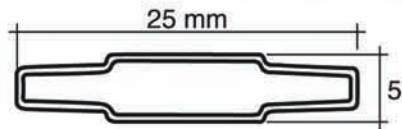

—BARROTILOS

ANODIZADO

ANODIZADO BRONCE

ANODIZADO INOX

ANODIZADO ORO

ANODIZADO PLATA

referencias	ml/caja*
ANODIZADO	
ANOD. BRONCE	225
ANOD. INOX	225
ANOD. ORO	225
ANOD. PLATA	225

*metros lineales por caja

LACADO MADERA

NAMBAR

PINO NUDO

SAPELY

referencias	ml/caja*
LACADO MADERA	
NAMBAR	225
PINO NUDO	225
SAPELY	225

*metros lineales por caja

■ **NOTA:** Sapely con cruceta exterior, el resto con cruceta interior.



GOBIERNO DEL PRINCIPADO DE ASTURIAS
IDEPA

Instituto de Desarrollo Económico del Principado de Asturias



FEDER

BARROTILO INTERIOR

BC-255 ACCESORIOS Y EJEMPLOS DE MONTAJE



Ref.: **X-255**

Cruceta exterior

400 uds/caja



Ref.: **TCI-255**

Tope interior

1000 uds/bolsa



Ref.: **XI-255**

Cruceta interior

400 uds/caja



Ref.: **TC-255**

Tope cabeza bola

1000 uds/bolsa



Ref.: **TCS-255**

Tope para grapar

1000 uds/bolsa

Ejemplos de montaje

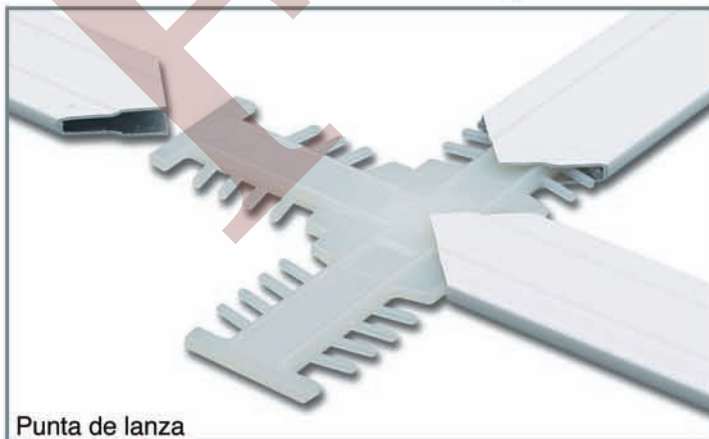

Punta de lanza

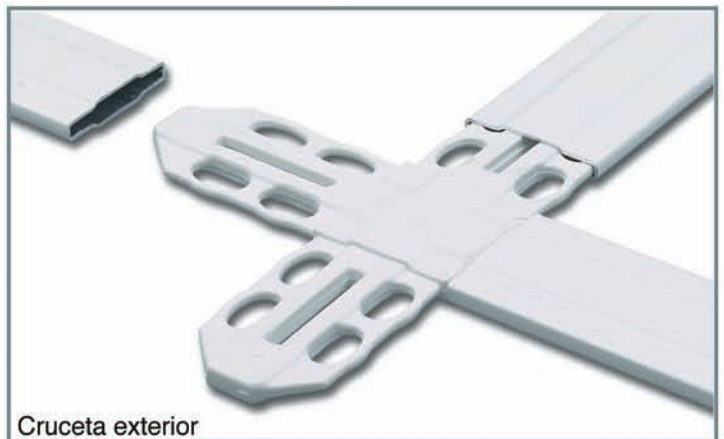

Cruceta exterior

BARROTILO INTERIOR

BC-080

BARROTILOS

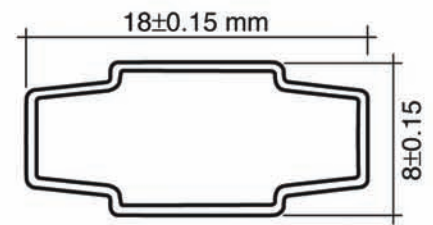

BLANCO RAL-9016

BURDEOS RAL-3005

MARRÓN RAL-8014

LACADO BRONCE

referencias	ml/caja*
BLANCO	408
BLANCO C.P.	360
RAL- 3005 C.P.	360
RAL- 8014 C.P.	360
LAC. BRONCE C.P.	180

*metros lineales por caja

BARROTILO INTERIOR

BC-080 ACCESORIOS Y EJEMPLOS DE MONTAJE

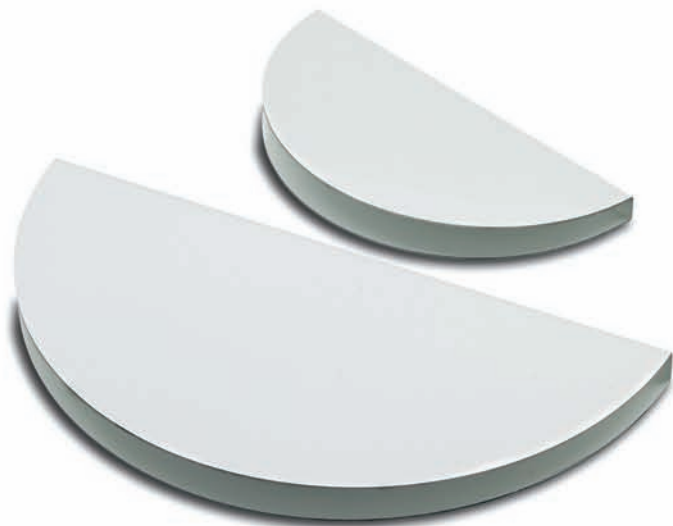

Ref.: **X-080**

Cruceta exterior

500 uds/caja

referencias	
SOL-055	100x50x5
SOL-080	100x50x8
SOL-155	150x75x5
SOL-158	150x75x8

COLORES:

blanco, bronce anodizado,
marrón, nogal, mbero.



Ref.: **TCS-080**

Tope para grapar

1000 uds/bolsa



Ref.: **TC-080**

Tope cabeza bola

1000 uds/bolsa



Ref.: **TCF-080**

Tope cabeza flecha

1000 uds/bolsa

EJEMPLOS DE MONTAJE

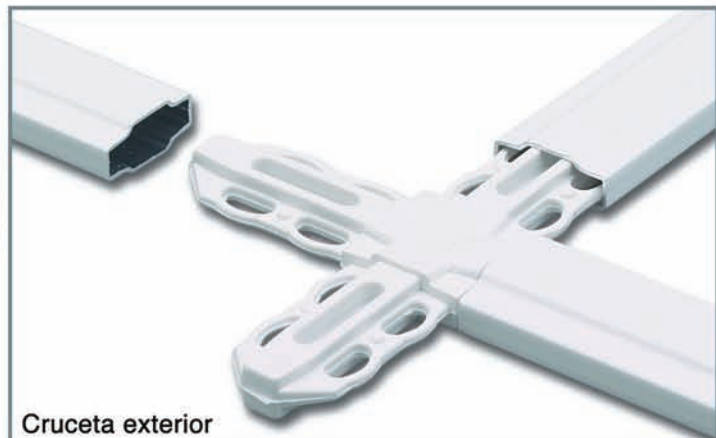

Cruceta exterior

BARROTILO INTERIOR

BC-I80

BARROTILOS

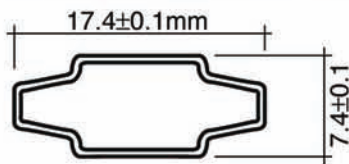

LACADO

ANODIZADO

BLANCO RAL-9016

ANODIZADO BRONCE

VERDE RAL-6005

ANODIZADO INOX

MARRÓN RAL-8014

ANODIZADO ORO

RAL-8017

ANODIZADO PLATA

LACADO BRONCE

referencias	ml/caja*
ANODIZADO	
ANOD. BRONCE	228
ANOD. INOX	228
ANOD. ORO	228
ANOD. PLATA	228

*metros lineales por caja

referencias	ml/caja*
LACADO	
BLANCO	450
BLANCO C.P.	450
RAL-6005 C.P.	450
RAL-8014 C.P.	450
RAL-8017 C.P.	450
LAC. BRONCE	450

*metros lineales por caja

NOTA: Todos con cruceta exterior, excepto ral-6005, ral-8017 y anodizados.

BARROTILO INTERIOR

BC-I80

BARROTILOS

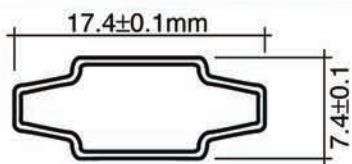

METALIZADO

LACADO MADERA

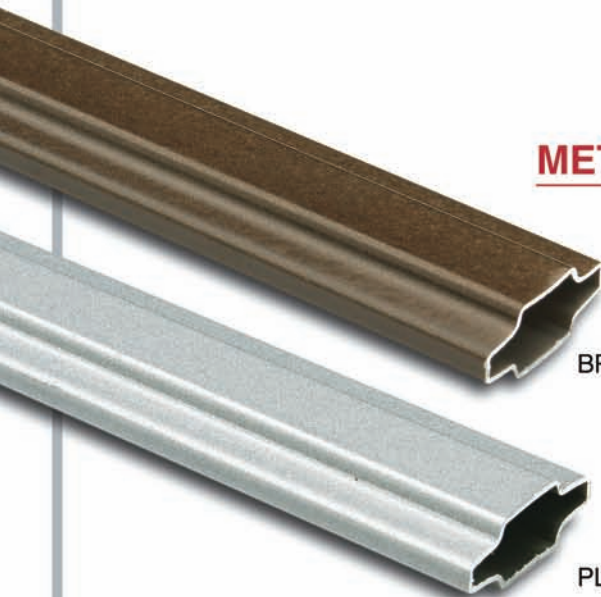

BRONCE METALIZADO

PLATA METALIZADO

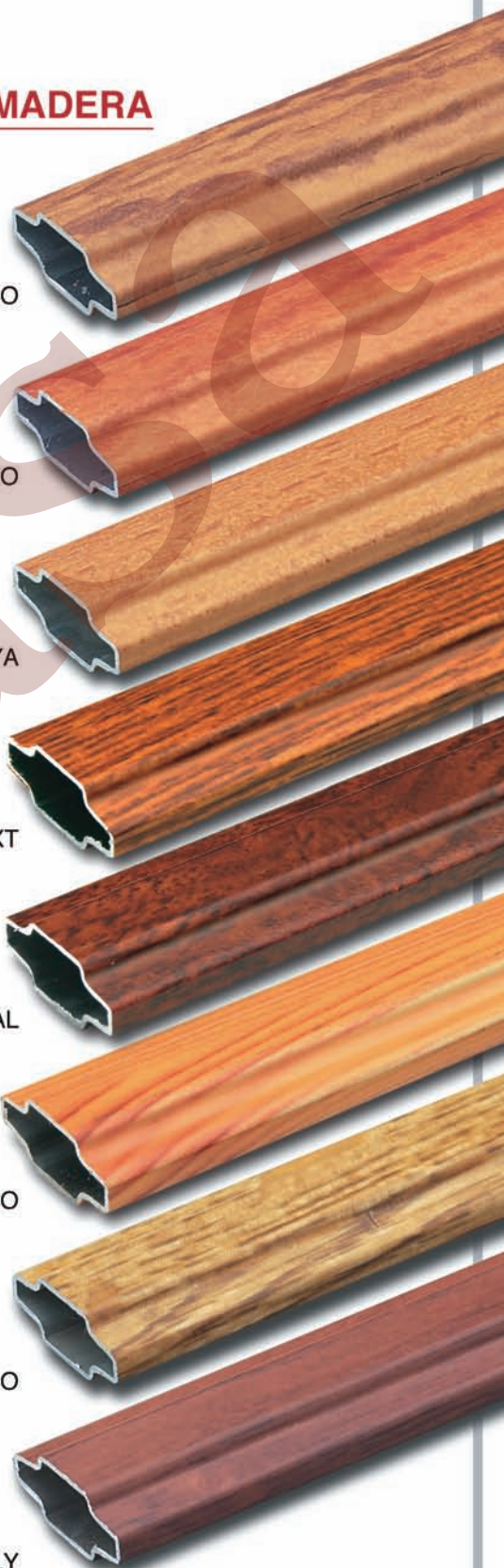

CASTAÑO

CEREZO

HAYA

MBERO TEXT

NOGAL

PINO NUDO

ROBLE AMERICANO

SAPELY

referencias	ml/caja*
METALIZADO	
BRONCE METAL.	228
PLATA METAL.	228

*metros lineales por caja

referencias	ml/caja*
LACADO MADERA	
CASTAÑO	228
CEREZO	228
HAYA	228
MBERO TEXT	228
PINO NUDO	228
ROBLE AMERIC.	228
SAPELY	228

*metros lineales por caja

■ **NOTA:** Todos con cruceta exterior, excepto mbero text, nogal y pino nudo.



GOBIERNO DEL PRINCIPADO DE ASTURIAS
IDEPA

Instituto de Investigación Económica del Principado de Asturias



FEDEP



BARROTILO INTERIOR

BC-I80

BARROTILOS

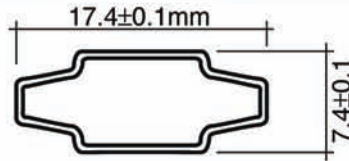

FOLEADO

BICOLOR

RENOLIT 2052089

RENOLIT 2178001/
BLANCO

RENOLIT 2052090

RENOLIT 2178007/
BLANCO

RENOLIT 2097013

RENOLIT 2178001

RENOLIT 2178007

RENOLIT 3069041

RENOLIT 3118076

RENOLIT 3149008

RENOLIT 3162002

referencias	ml/caja*
BICOLOR	
RENOLIT 2178001/BLANCO	201
RENOLIT 2178007/BLANCO	201

*metros lineales por caja

referencias	ml/caja*
FOLEADO	
RENOLIT 2052089	201
RENOLIT 2052090	201
RENOLIT 2097013	201
RENOLIT 2178001	201
RENOLIT 2178007	201
RENOLIT 3069041	201
RENOLIT 3118076	201
RENOLIT 3149008	201
RENOLIT 3162002	201

*metros lineales por caja

NOTA: Todos con cruceta interior.

BARROTILO INTERIOR

BC-I80

ACCESORIOS



Ref.: **X-I80**

Cruceta exterior

300 uds/caja



Ref.: **XI-I80**

Cruceta interior

300 uds/caja



Ref.: **XY-I80**

Cruceta tres salidas

300 uds/caja



Ref.: **XP-I80**

Cruceta perforada

300 uds/caja

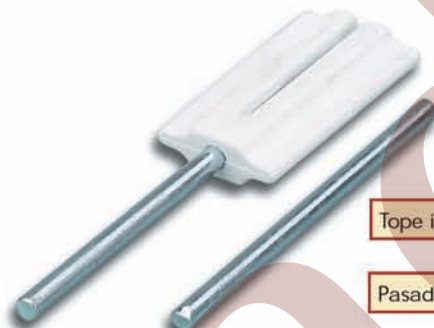

Ref.: **TCI-I80**

Tope interior

1000 uds/bolsa

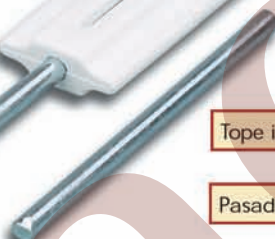

Ref.: **PS-I80**

Pasador para TCI

1000 uds/caja

Ref.: **Amort**

Amortiguador

600 uds/bolsa



Ref.: **TC-I80**

Tope cabeza bola

1000 uds/bolsa



Ref.: **TCF-I80**

Tope cabeza flecha

1000 uds/bolsa



Ref.: **TCS-I80**

Tope para grapar

1000 uds/bolsa



Ref.: **TCIF-I80**

Tope imitación fresado

1000 uds/bolsa



Ref.: **RAD-I80**

Radio para abanico

1000 uds/bolsa



Ref.: **Abanico**

18 x 8 mm.

BARROTILO INTERIOR

BC-I80

EJEMPLOS DE MONTAJE

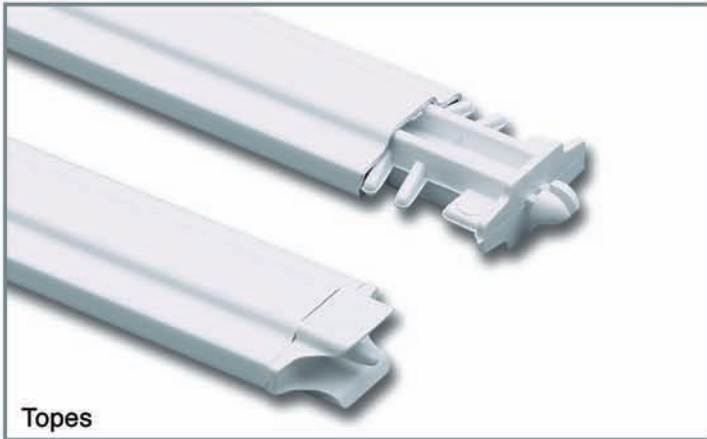

Topes

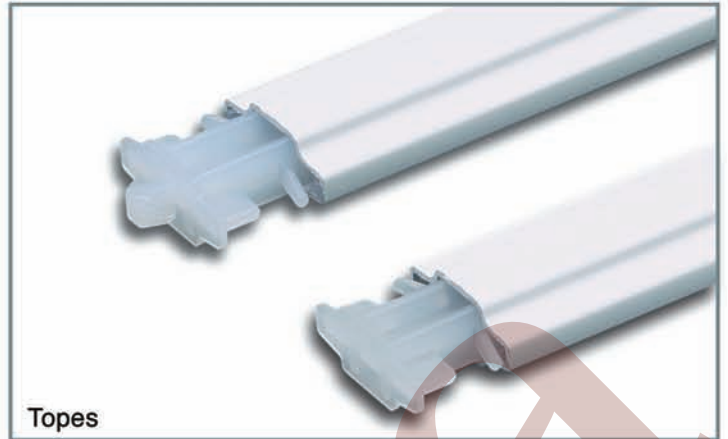

Topes

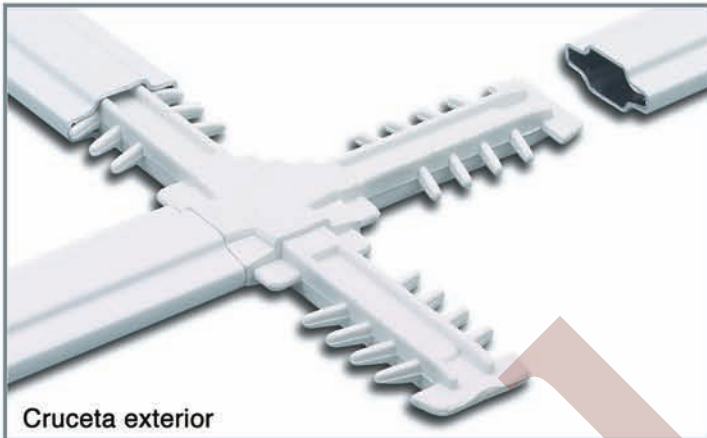

Cruceta exterior

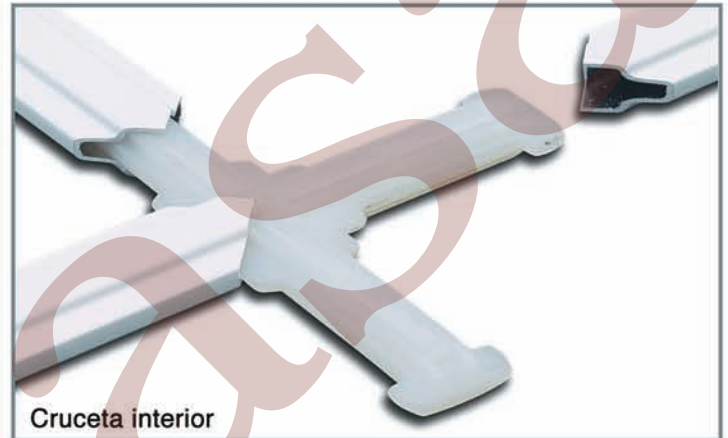

Cruceta interior



Cruceta de tres salidas

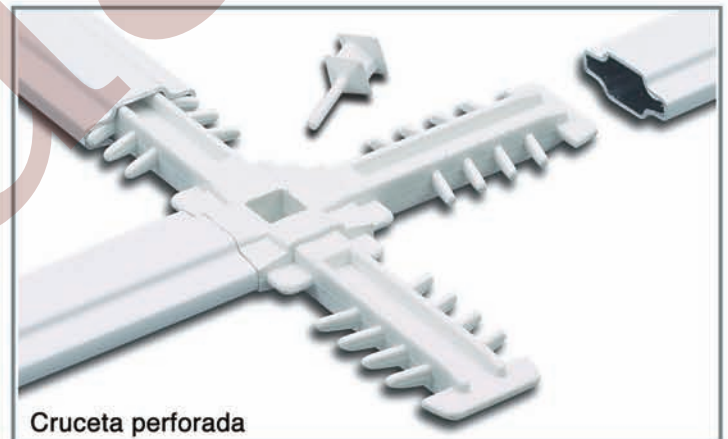

Cruceta perforada

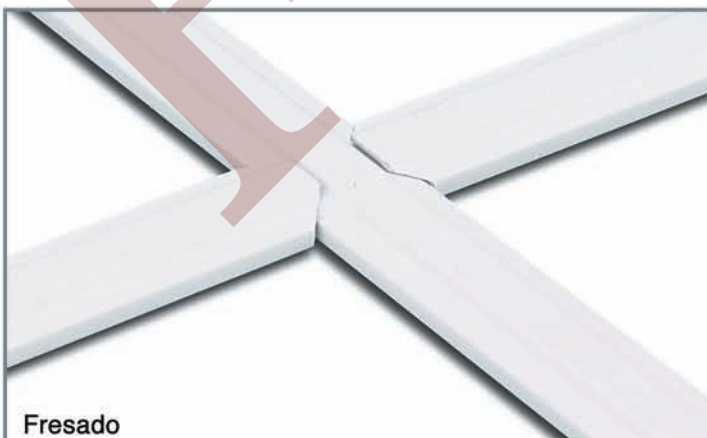

Fresado



Perfil curvado

BARROTILO INTERIOR

BC-258

BARROTILOS

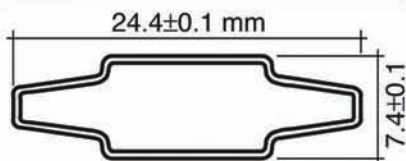

LACADO

METALIZADO

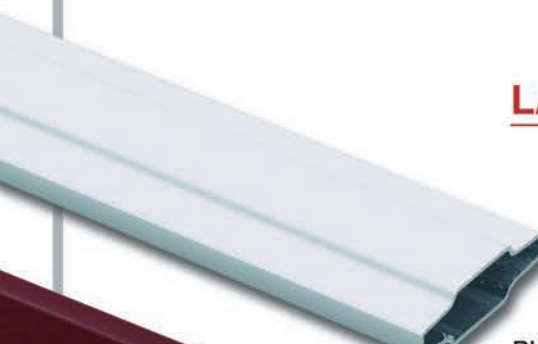

BLANCO RAL-9016

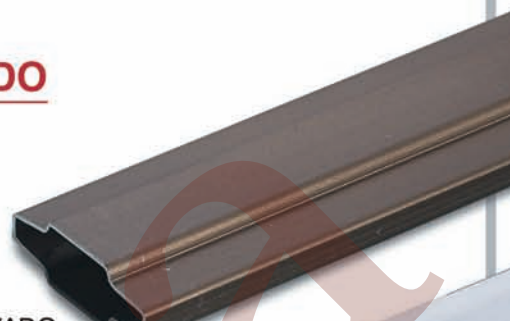

BRONCE METALIZADO

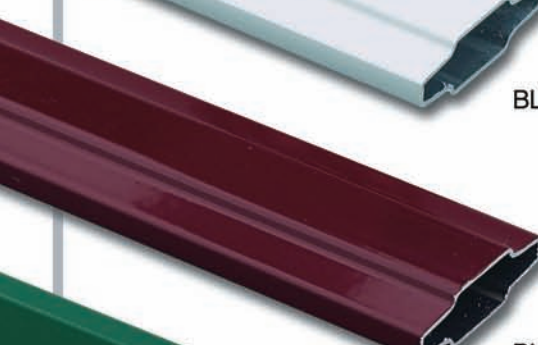

BURDEOS RAL-3005

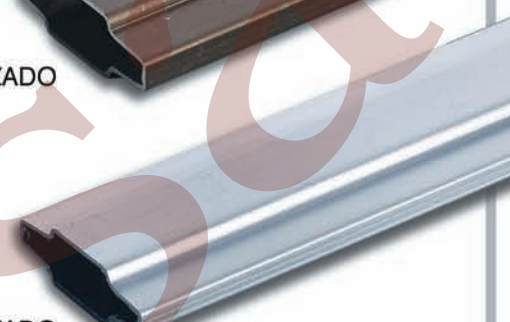

PLATA METALIZADO

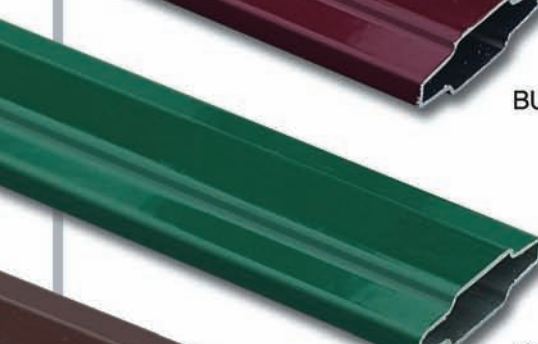

VERDE RAL-6005

referencias	ml/caja*
METALIZADO	
BRONCE METAL.	171
PLATA METAL.	171

*metros lineales por caja

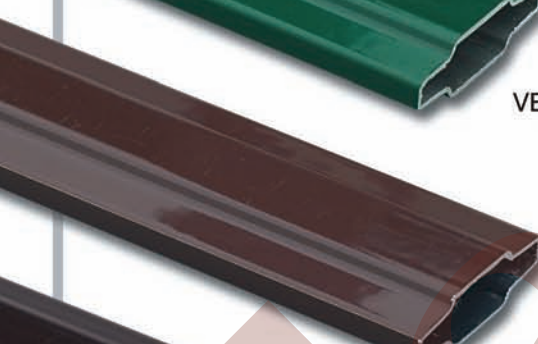

MARRÓN RAL-8014

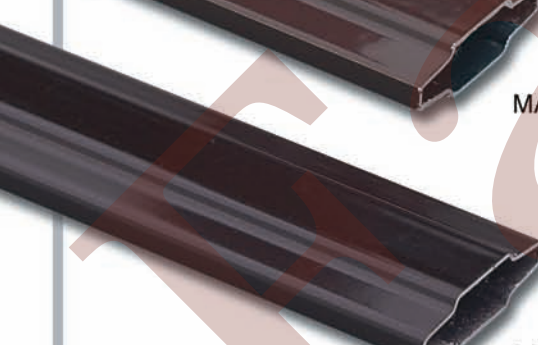

LACADO BRONCE

referencias	ml/caja*
LACADO	
BLANCO	324
BLANCO C.P.	300
RAL-3005 C.P.	300
RAL-6005 C.P.	300
RAL-8014 C.P.	150
LACADO BRONCE	300

*metros lineales por caja

NOTA: Todos con cruceta exterior excepto ral-3005 y ral-6005.

BARROTILO INTERIOR

BC-258

BARROTILOS

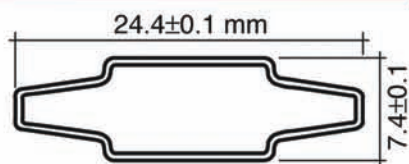

LACADO MADERA



CASTAÑO

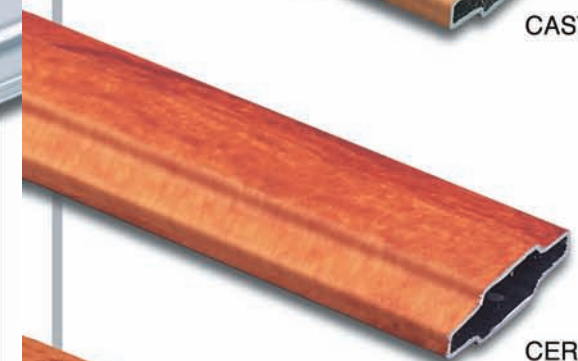

CEREZO

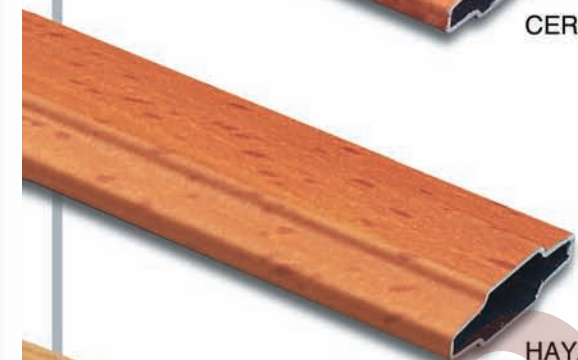

HAYA



ROBLE



SAPELY

referencias	ml/caja*
LACADO MADERA	
CASTAÑO	171
CEREZO	171
HAYA	171
ROBLE AMERICAN.	171
SAPELY	171

*metros lineales por caja

■ **NOTA:** Todos con cruceta exterior.



GOBIERNO DEL PRINCIPADO DE ASTURIAS



IDEPA

Instituto de Investigación Económica del Principado de Asturias



FEDER



19

BARROTILLO INTERIOR

BC-258

ACCESORIOS

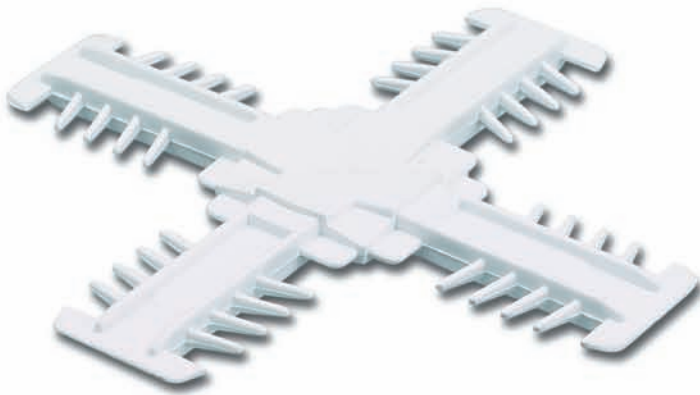

Ref.: X-258

Cruceta exterior

250 uds./caja

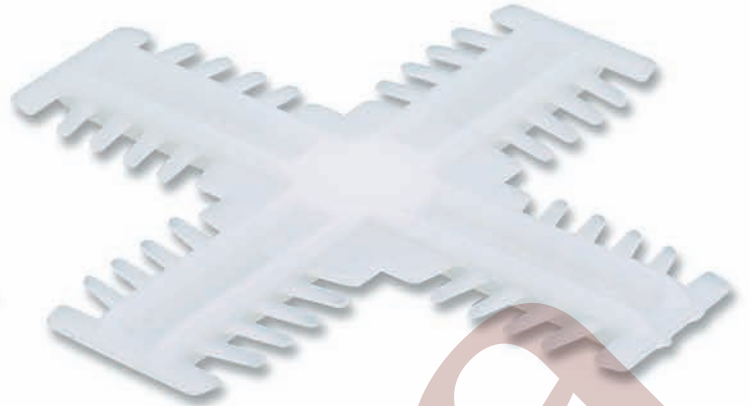

Ref.: XI-725

Cruceta interior

300 uds./caja



Ref.: XY-258

Cruceta tres salidas

200 uds./caja



Ref.: Abanico



Ref.: TC-258

Tope cabeza bola

1000 uds./bolsa



Ref.: TXF-725

Tope cabeza flecha

1000 uds./bolsa



Ref.: TXS-725

Tope para grapar

1000 uds./bolsa



Ref.: TCIF-258

Tope imitación fresado

400 uds./bolsa

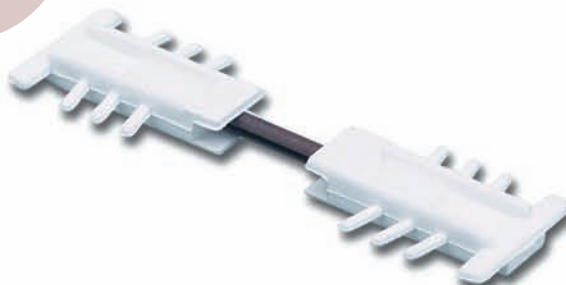

Ref.: TCI-258

Tope interior

1000 uds./bolsa



Ref.: PS-258

Pasador para TCI

500 uds./caja



Ref.: RAD-258

Radio para abanico

400 uds./bolsa

20



IDEPA

Instituto de Investigación Económica del Principado de Asturias



FEDER

BARROTILO INTERIOR

BC-258

EJEMPLOS DE MONTAJE

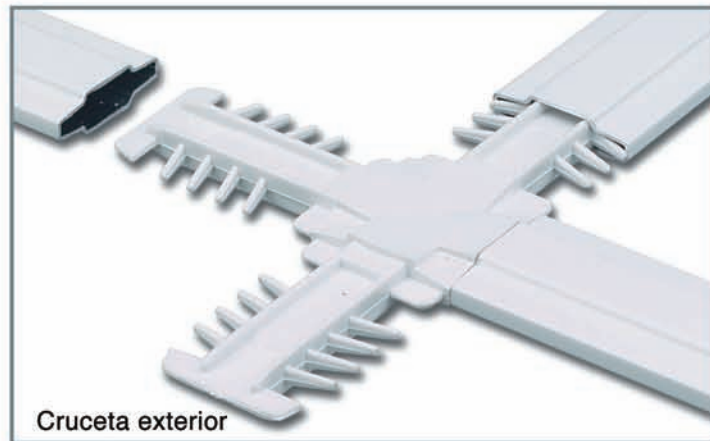

Cruceta exterior

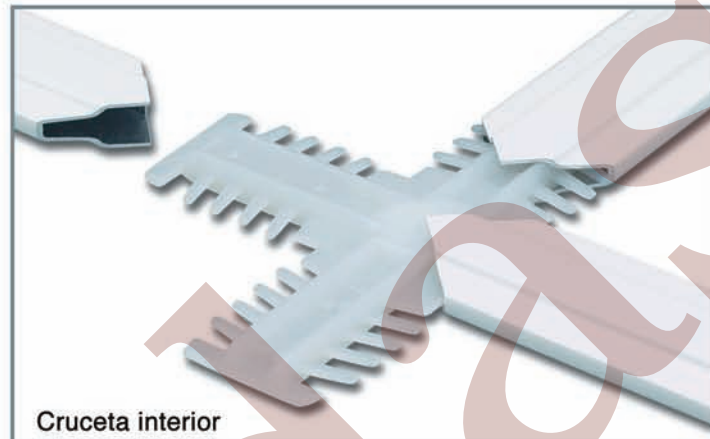

Cruceta interior



Cruceta de tres salidas



Abanico y radio

BARROTILO INTERIOR

BC-068

BARROTILOS

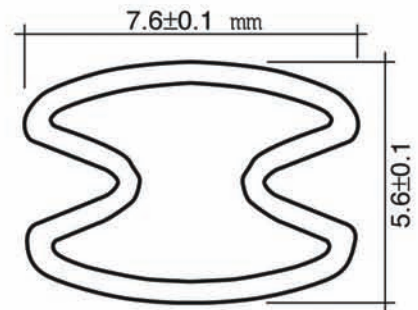

BLANCO RAL-9016

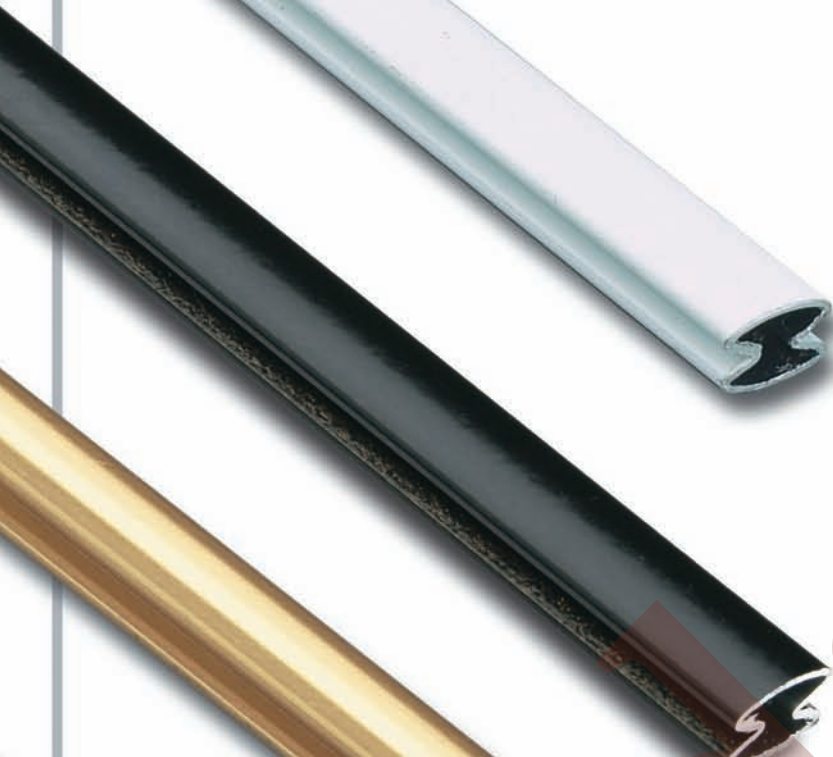

NEGRO RAL-9011



ORO ANODIZADO



PLATA METALIZADO

referencias	m/caja*
BLANCO	360
NEGRO	360
ORO ANODIZADO	360
PLATA METAL.	360

*metros lineales por caja

■ **NOTA:** Resto de acabados, consultar.



BARROTILLO INTERIOR

BC-068

ACCESORIOS



Ref.: XAL-068

Embellecedor aluminio

420 uds/caja



Ref.: XPO-068

Cruceta plástico

420 uds/caja



Ref.: YAL-068

Embellecedor tres salidas 90°

364 uds/caja



Ref.: YPO-068

Cruceta tres salidas 90°

364 uds/caja



Ref.: Y60°-068

Cruceta tres salidas 60°

364 uds/caja



Ref.: Y120°-068

Cruceta tres salidas 120°

364 uds/caja



Ref.: TAL-068

Embellecedor en "T"

364 uds/caja



Ref.: TPO-068

"T" plástico

364 uds/caja



Ref.: LAL-068

Embellecedor en "L"

364 uds/caja



Ref.: LPO-068

"L" plástico

364 uds/caja

BARROTILO INTERIOR

BC-068

ACCESORIOS



Ref.: **TCAL-068**

Tope aluminio

672 uds/caja



Ref.: **TCPO-068**

Tope plástico

672 uds/bolsa



Ref.: **TCPOD-068**

Tope plástico cuello largo

672 uds/bolsa



Ref.: **TCS-068**

Tope para grapar

672 uds/bolsa



Ref.: **RAD-068**

Radio para SOLPO

672 uds/bolsa

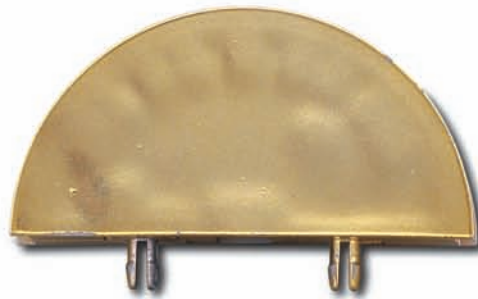

Ref.: **SOLPO-068**

Sol plástico

150 uds/caja



Ref.: **SOLAL-068**

Embellecedor SOLPO

150 uds/caja

EJEMPLO MONTADO

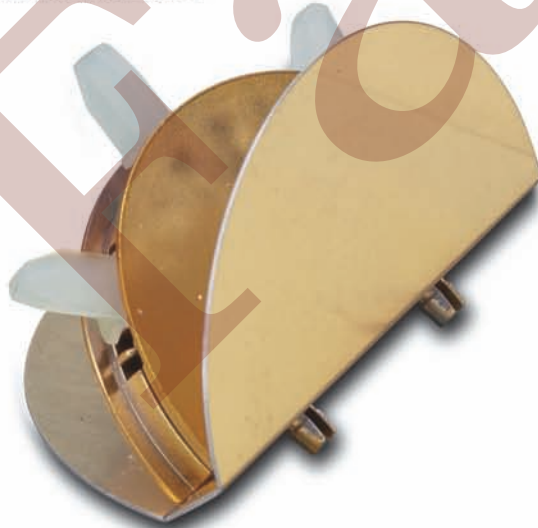

Ref.: **EMBELLEC. BC-068**

Embellecedor

150 uds/caja

■ **NOTA:** Todos los accesorios en blanco, negro y oro.

BARROTILO INTERIOR

BC-068

EJEMPLOS DE MONTAJE

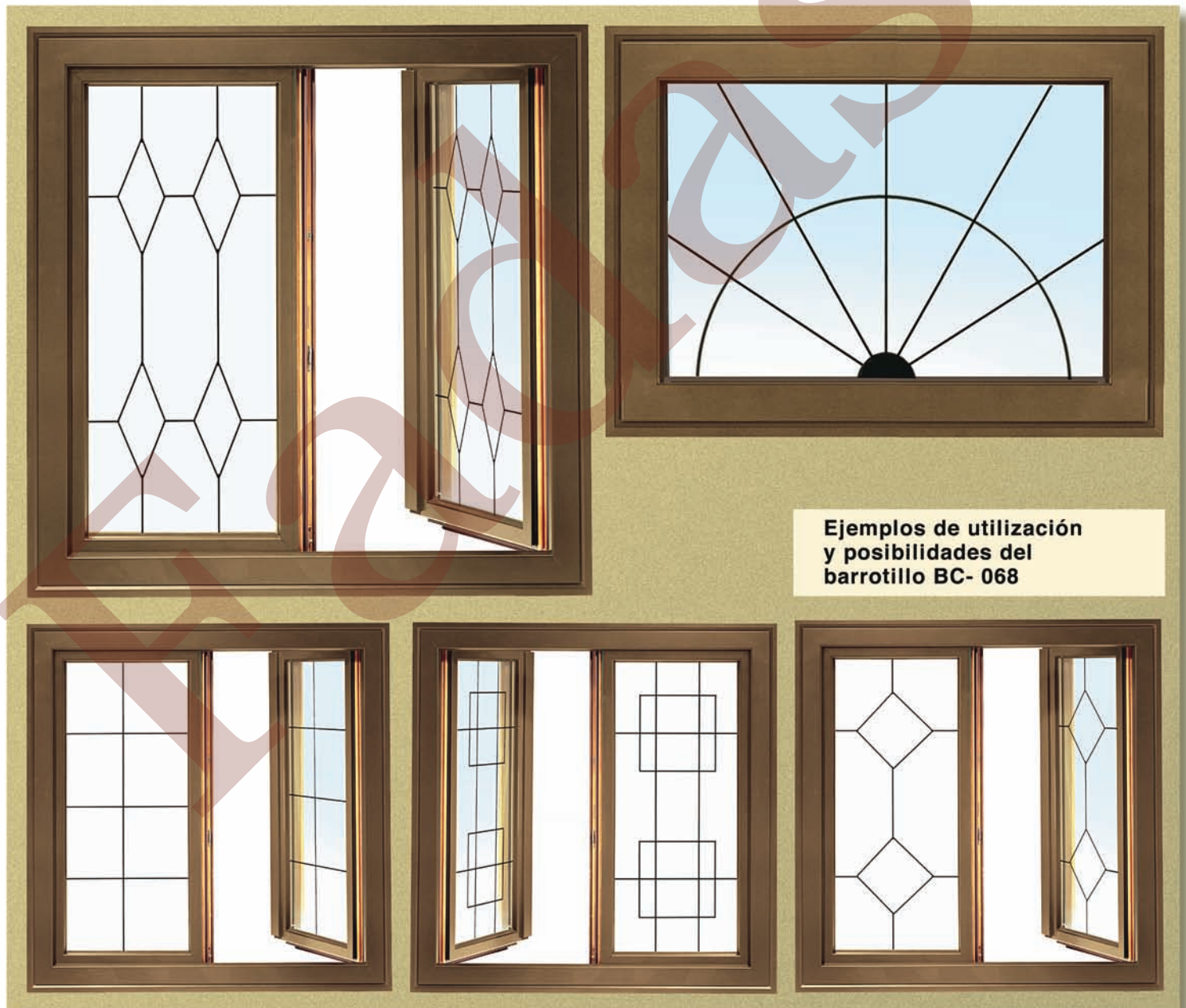
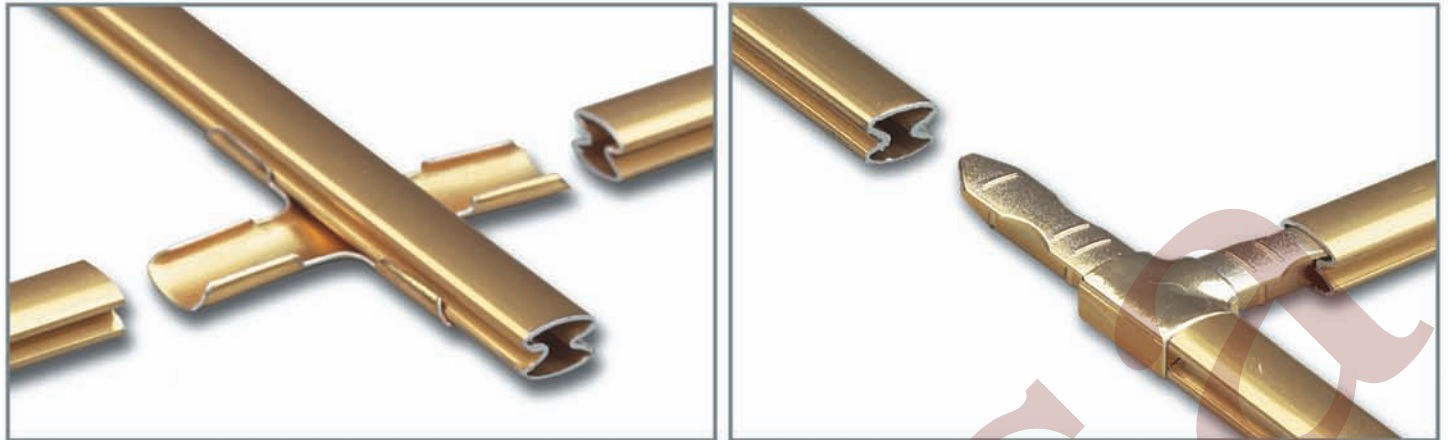

Ejemplos de utilización
y posibilidades del
barrotillo BC- 068

BARROTILO INTERIOR

BC-525 ASTURIANO

BARROTILOS

LACADO

ANODIZADO

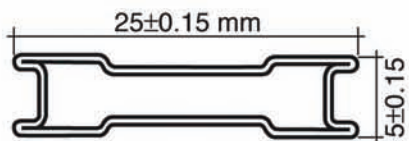

BLANCO RAL-9016

ANODIZADO BRONCE

RAL-1015

ANODIZADO INOX

BURDEOS RAL-3005

ANODIZADO ORO

VERDE RAL-6005

ANODIZADO PLATA

RAL-6009

MARRÓN RAL-8014

referencias	ml/caja*
ANODIZADO	
ANOD. BRONCE	222
ANOD. INOX	222
ANOD. ORO	222
ANOD. PLATA	222

*metros lineales por caja

referencias	ml/caja*
LACADO	
BLANCO	222
RAL-1015	222
RAL-3005	222
RAL-6005	222
RAL-6009	222
RAL-8014	222

*metros lineales por caja

BARROTILO INTERIOR

BC-525 ASTURIANO — BARROTILOS

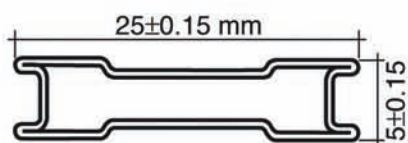

LACADO MADERA

CASTAÑO

CEREZO

HAYA

PINO NUDO

ROBLE AMERICANO

SAPELY

referencias	ml/caja*
LACADO MADERA	
CASTAÑO	300
CEREZO	300
HAYA	300
PINO NUDO	222
ROBLE AMERIC.	222
SAPELY	222

*metros lineales por caja

BARROTILO INTERIOR

BC-525 ASTURIANO

BARROTILOS

FOLEADO

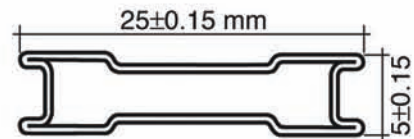

RENOLIT 2052089

RENOLIT 2178001

RENOLIT 2178007

RENOLIT 3149008

referencias	ml/caja*
FOLEADO	
RENOLIT 2052089	189
RENOLIT 2178001	189
RENOLIT 2178007	189
RENOLIT 3149008	189

*metros lineales por caja

BICOLOR

RENOLIT 2178001/BLANCO

referencias	ml/caja*
BICOLOR	
RENOLIT 2178001/BLANCO	189

*metros lineales por caja

BARROTILO INTERIOR

BC-525 ASTURIANO

ACCESORIOS Y EJEMPLOS DE MONTAJE



Ref.: TCC-525

Tope cabeza bola

1000 uds./bolsa



Ref.: TCF-525

Tope cabeza flecha

1000 uds./bolsa



Ref.: TCS-525

Tope para grapar

1000 uds./bolsa



Ref.: PS-525

Pasador para TCI

1000 uds./caja

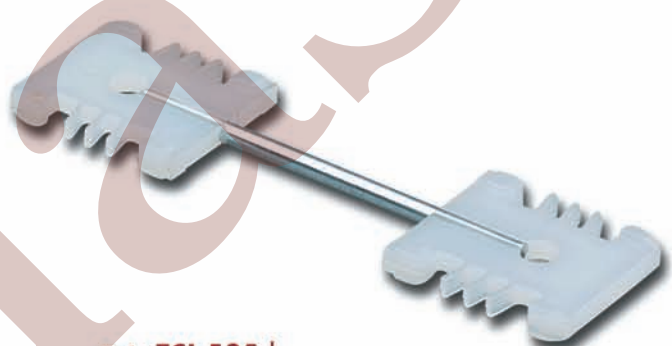

Ref.: TCI-525

Tope interior

1000 uds./bolsa

EJEMPLOS DE MONTAJE

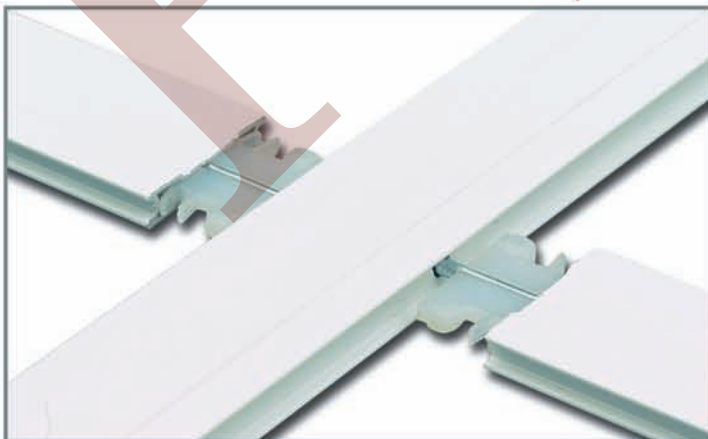

BARROTILO INTERIOR

BC-725 ASTURIANO

BARROTILOS

LACADO

ANODIZADO

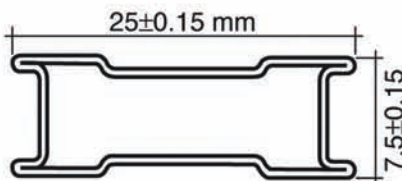

BLANCO RAL-9016



ANODIZADO BRONCE

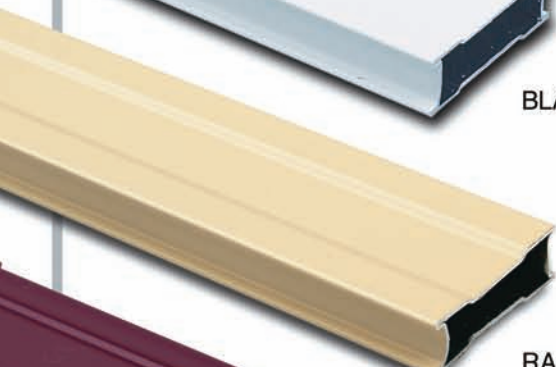

RAL-1015

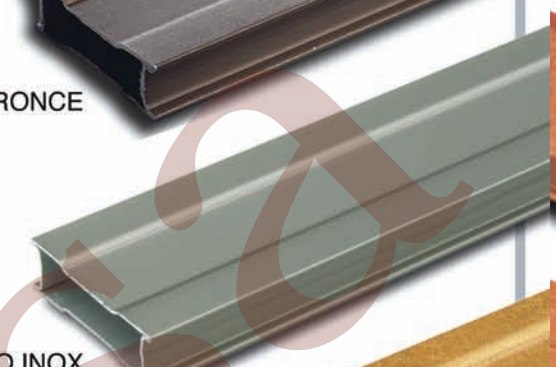

ANODIZADO INOX



BURDEOS RAL-3005

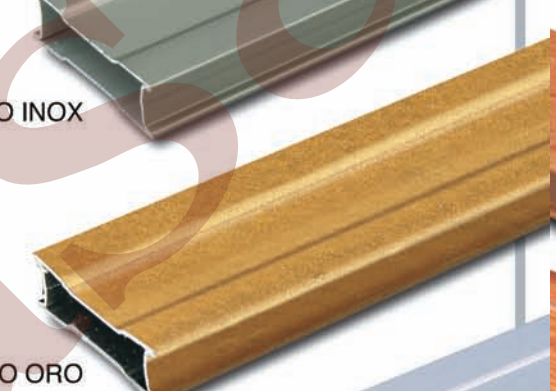

ANODIZADO ORO

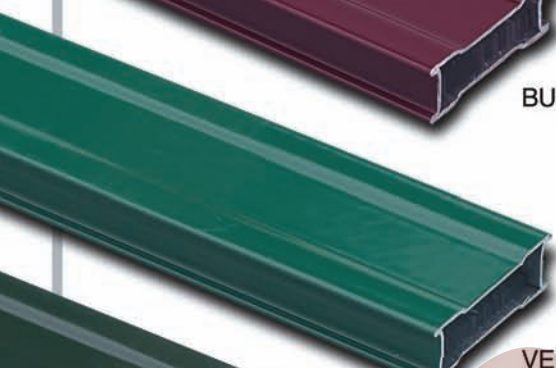

VERDE RAL-6005

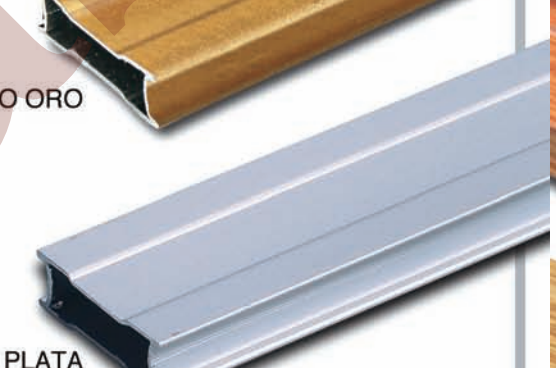

ANODIZADO PLATA

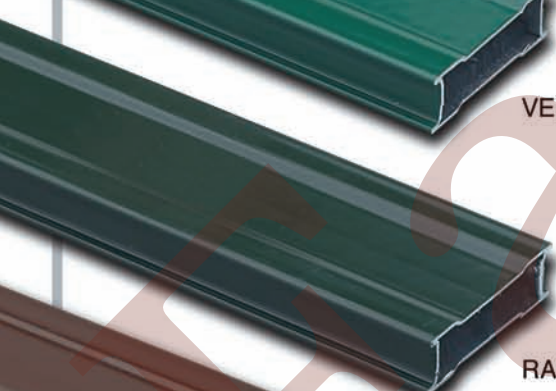

RAL-6009

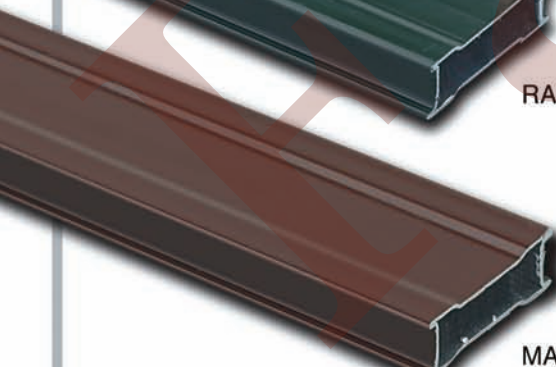

MARRÓN RAL-8014

referencias	ml/caja*
ANODIZADO	
ANOD. BRONCE	150
ANOD. INOX	150
ANOD. ORO	150
ANOD. PLATA	150

*metros lineales por caja

referencias	ml/caja*
LACADO	
BLANCO	300
RAL-1015	300
RAL-3005	300
RAL-6005	300
RAL-6009	300
RAL-8014	300

*metros lineales por caja



BARROTILO INTERIOR

BC-725 ASTURIANO

BARROTILOS

LACADO MADERA

FOLEADO

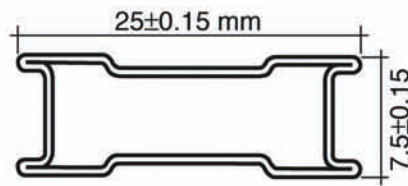

CASTAÑO

PENOLIT 2052089

CEREZO

RENOLIT 2178001

HAYA

RENOLIT 2178007

PINO NUDO

RENOLIT 3149008

ROBLE AMERICANO

SAPELY

BICOLOR

RENOLIT 2178001/BLANCO

referencias	ml/caja*
FOLEADO	
RENOLIT 2052089	135
RENOLIT 2178001	135
RENOLIT 2178007	135
RENOLIT 3149008	135

*metros lineales por caja

referencias	ml/caja*
LACADO MADERA	
CASTAÑO	300
CEREZO	300
HAYA	300
PINO NUDO	150
ROBLE AMERICAN.	150
SAPELY	150

*metros lineales por caja

referencias	ml/caja*
BICOLOR	
RENOLIT 2178001/BLANCO	135

*metros lineales por caja

BARROTILO INTERIOR

BC-725 ASTURIANO

ACCESORIOS Y EJEMPLOS DE MONTAJE



Ref.: **TCC-725**

Tope cabeza bola

1000uds/bolsa



Ref.: **TCF-725**

Tope para grapar

1000uds/bolsa



Ref.: **TCS-725**

Tope cabeza flecha

1000uds/bolsa

EJEMPLOS DE MONTAJE

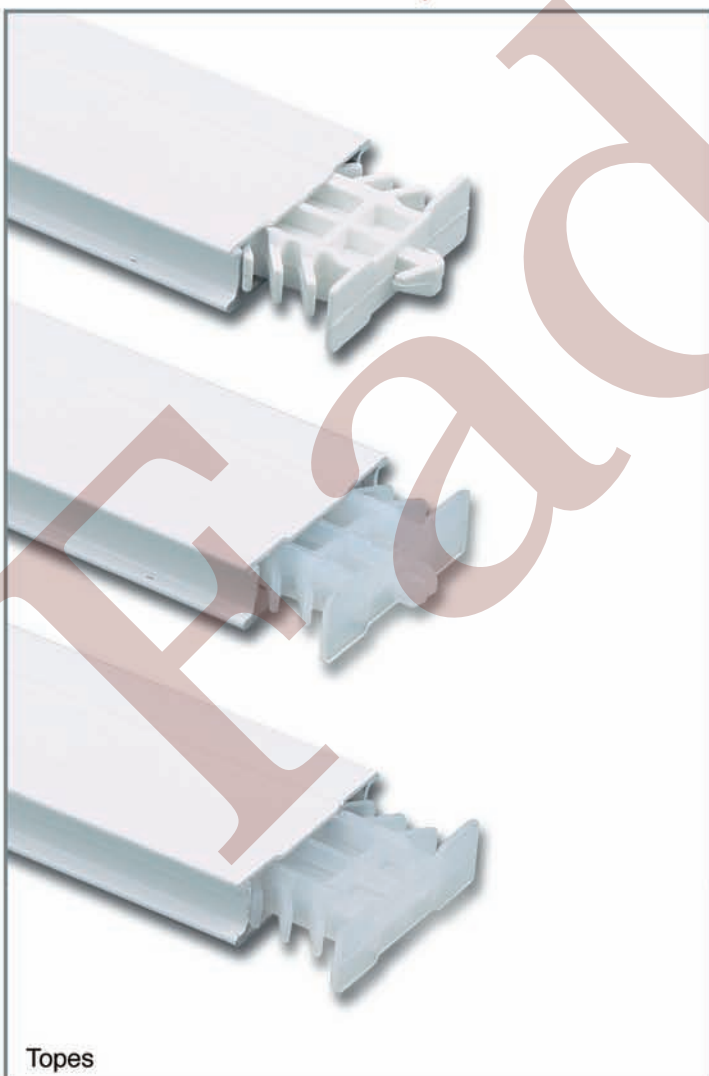

Topes



Topes



GOBIERNO DEL PRINCIPADO DE ASTURIAS



IDEPA

Instituto de Investigación Económica del Principado de Asturias



FEDER

32

BARROTILO INTERIOR

BX-725

BARROTILOS

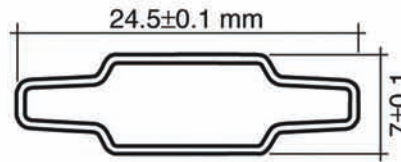

LACADO

ANODIZADO



BLANCO RAL-9016



ANODIZADO BRONCE



RAL-1015

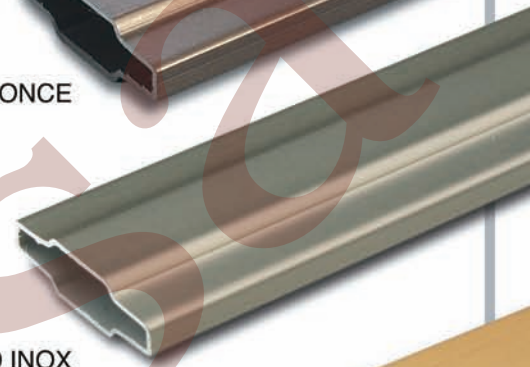

ANODIZADO INOX

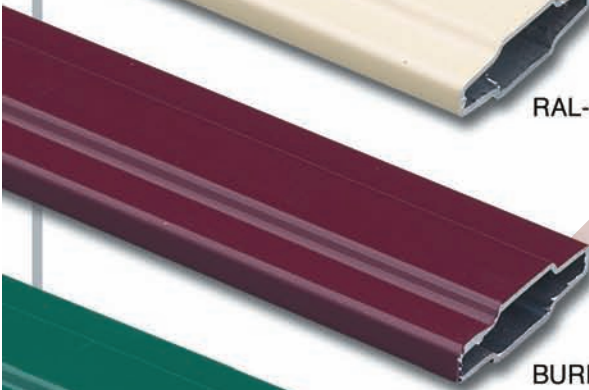

BURDEOS RAL-3005

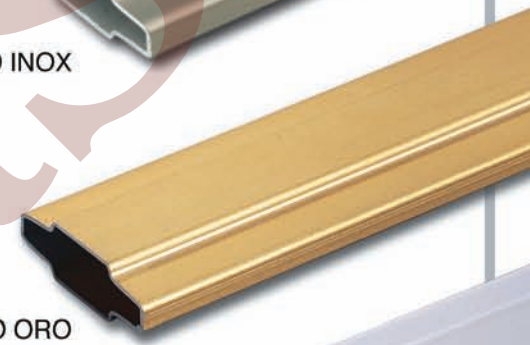

ANODIZADO ORO

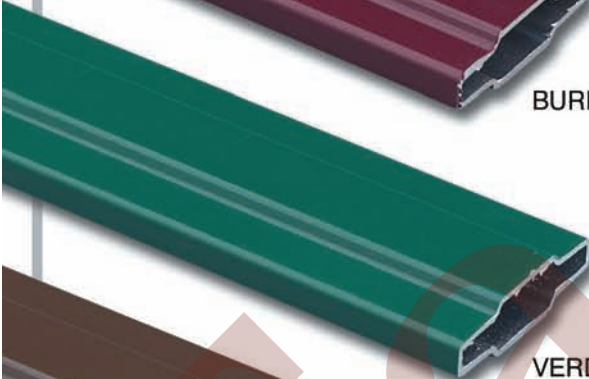

VERDE RAL-6005



ANODIZADO PLATA

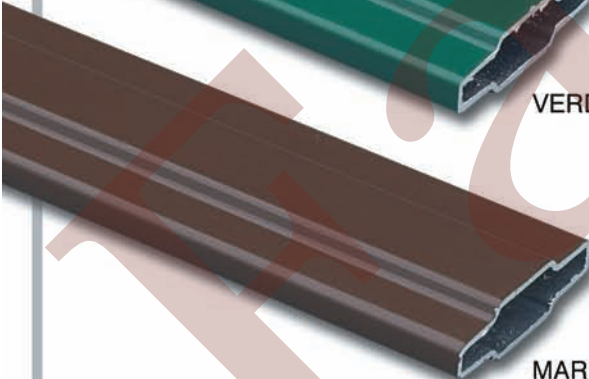

MARRÓN RAL-8014

referencias	ml/caja*
ANODIZADO	
ANOD. BRONCE	150
ANOD. INOX	150
ANOD. ORO	150
ANOD. PLATA	150

*metros lineales por caja

referencias	ml/caja*
LACADO	
BLANCO	300
RAL-1013	300
RAL-3005	300
RAL-6005	300
RAL-8014	300

*metros lineales por caja

NOTAS:

- Todos con cruceta interior.
- Especial punta de lanza.

BARROTILO INTERIOR

BX-725

BARROTILOS

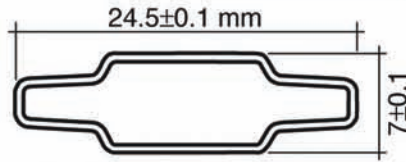

LACADO MADERA

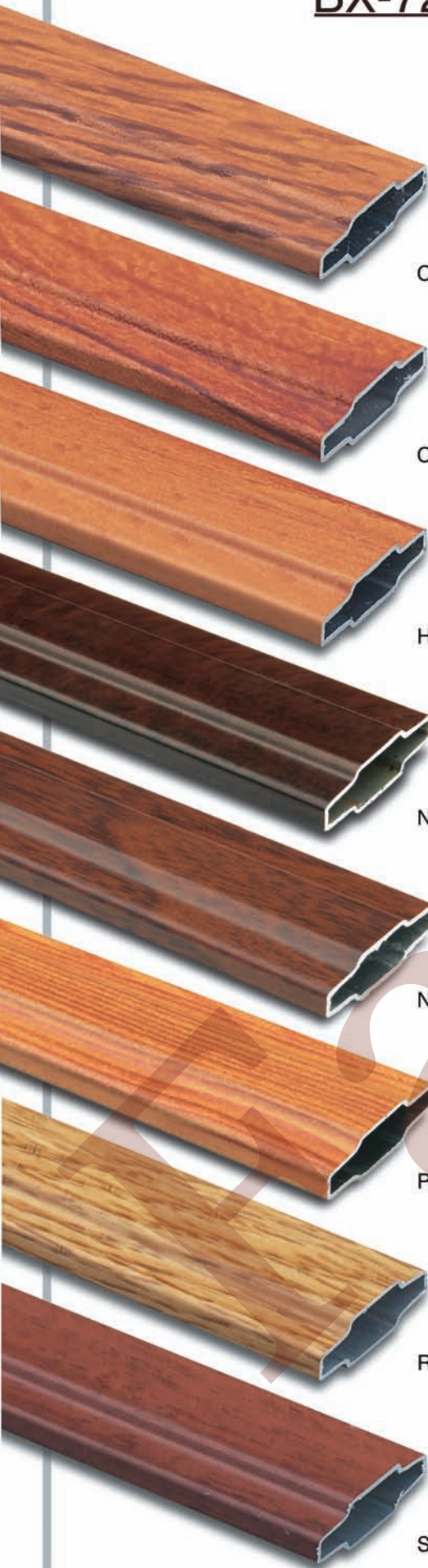

CASTAÑO

CEREZO

HAYA

NAMBAR

NOGAL

PINO NUDO

ROBLE AMERICANO

SAPELY

referencias	ml/caja*
LACADO MADERA	
CASTAÑO	171
CEREZO	171
HAYA	171
NAMBAR	171
NOGAL	171
PINO NUDO	150
ROBLE AMERIC.	171
SAPELY	171

*metros lineales por caja

NOTAS:

- Todos con cruceta interior.
- Especial punta de lanza.

BARROTILO INTERIOR

BX-725

BARROTILOS

FOLEADO

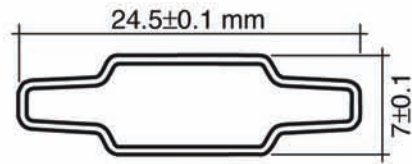

RENOLIT 2052089

RENOLIT 2052090

RENOLIT 2097013

RENOLIT 21780001

RENOLIT 2178007

RENOLIT 3069041

RENOLIT 3118076

RENOLIT 3149008

RENOLIT 3152009

RENOLIT 3162002

referencias	ml/caja*
FOLEADO	
RENOLIT 2052089	150
RENOLIT 2052090	150
RENOLIT 2097013	150
RENOLIT 2178001	150
RENOLIT 2178007	150
RENOLIT 3069041	150
RENOLIT 3118076	150
RENOLIT 3149008	150
RENOLIT 3152009	150
RENOLIT 3162002	150

*metros lineales por caja

NOTAS:

- Todos con cruceta interior.
- Especial punta de lanza.

BARROTILO INTERIOR

BX-725

BARROTILLOS

BICOLOR

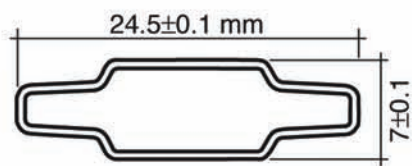

RENOLIT 2052089/BLANCO

RENOLIT 2052090/BLANCO

RENOLIT 2097013/BLANCO

RENOLIT 2178001/BLANCO

RENOLIT 3069041/BLANCO

RENOLIT 3118076/BLANCO

RENOLIT 3149008/BLANCO

RENOLIT 3162002/BLANCO

referencias	ml/caja*
BICOLOR	
RENOLIT 2052089/BLANCO	150
RENOLIT 2052090/BLANCO	150
RENOLIT 2097013/BLANCO	150
RENOLIT 2178001/BLANCO	150
RENOLIT 3069041/BLANCO	150
RENOLIT 3118076/BLANCO	150
RENOLIT 3149008/BLANCO	150
RENOLIT 3162002/BLANCO	150

*metros lineales por caja

NOTAS:

- Todos con cruceta interior.
- Especial punta de lanza.

BARROTILO INTERIOR

BX-725

ACCESORIOS

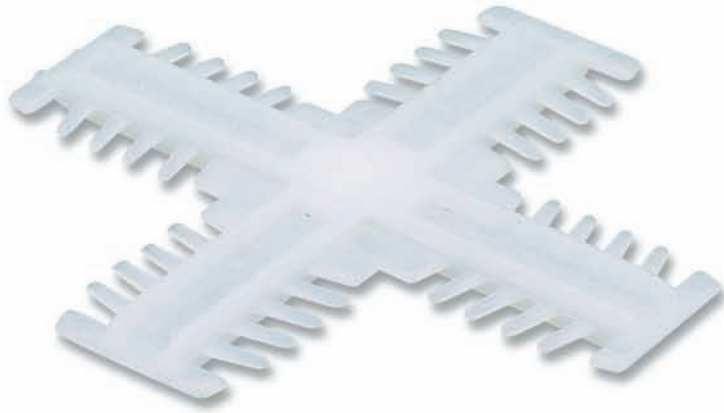

Ref.: **XI-725**

Cruceta interior

300 uds/caja

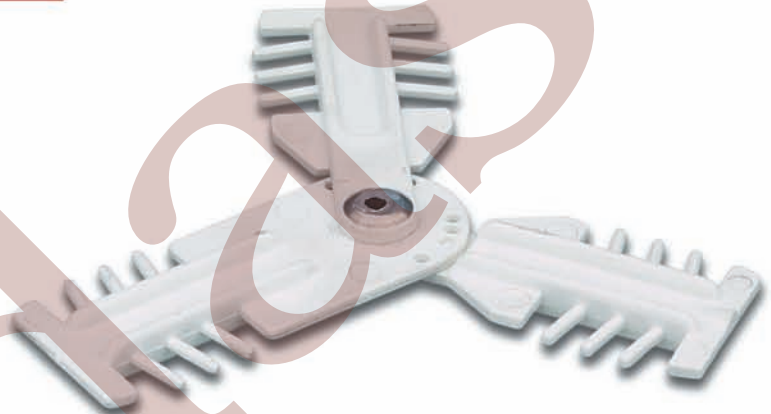

Ref.: **YI-725**

Cruceta interior de tres salidas.
Regulable

500 uds/caja



Ref.: **TXF-725**

Tope cabeza flecha

1000 uds/bolsa



Ref.: **TXC-725**

Tope cabeza bola

1000 uds/bolsa



Ref.: **TXS-725**

Tope para grapar

1000 uds/bolsa

BARROTILO INTERIOR

BX-725

EJEMPLOS DE MONTAJE

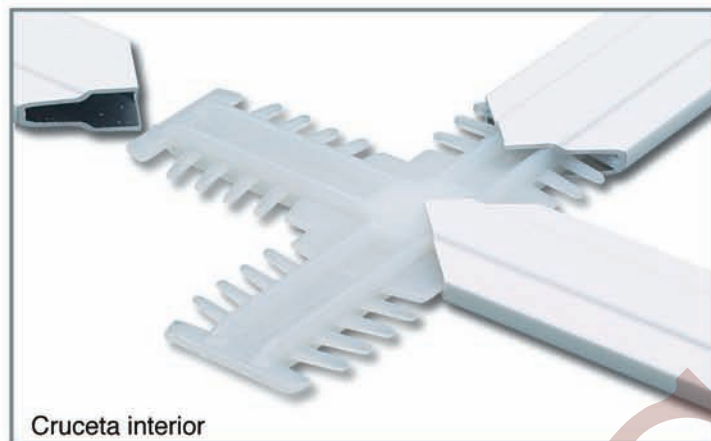

Cruceta interior



Cruceta tres salidas

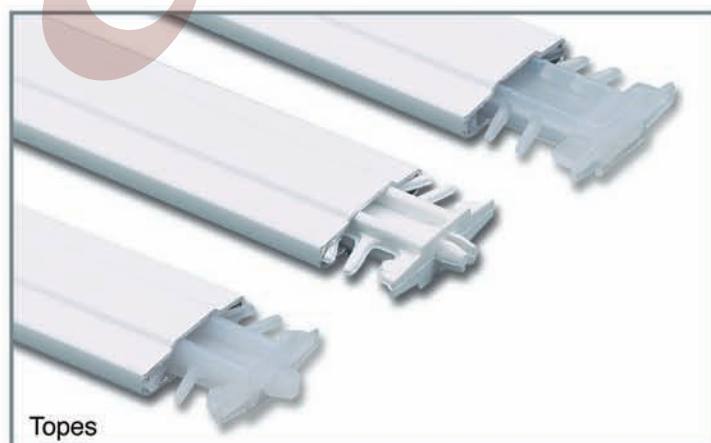

Topes

BARROTILO INTERIOR

BX-255

BARROTILOS

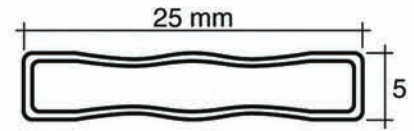

BLANCO RAL-9016



MARRÓN RAL-8014

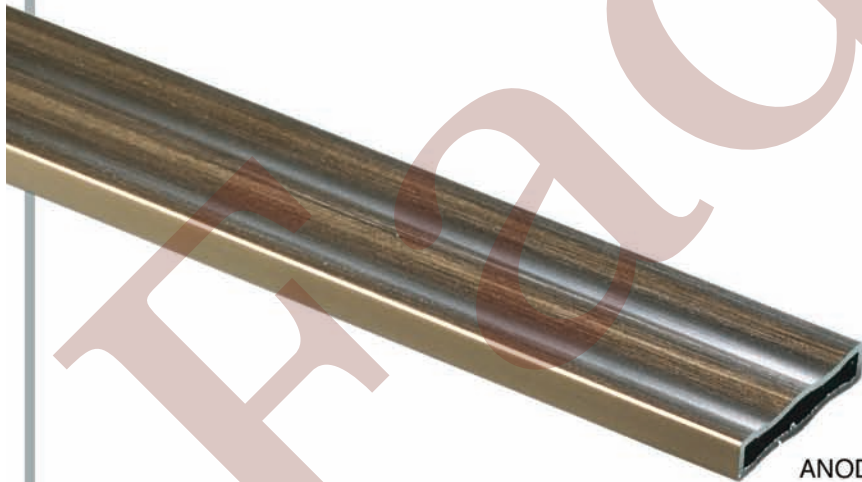

ANODIZADO BRONCE

referencias	ml/caja*
TODOS LOS COLORES	225

*metros lineales por caja

BARROTILO INTERIOR

BX-255 ACCESORIOS Y EJEMPLOS DE MONTAJE



Ref.: **PT-255**

Pletina de unión

500 uds/caja



Ref.: **TX-255**

Tope cabeza bola

1000 uds/bolsa



Ref.: **TXS-255**

Tope para grapar

1000 uds/bolsa

EJEMPLOS DE MONTAJE



Topes

